

**SEIKO**

**QUARTZ**

**LC**  
**(Cal. 0624A)**

**PARTS LIST**

<b>Calibre No.</b> <h1 style="text-align: center;">0624A</h1>	<b>Jewels</b> <h1 style="text-align: center;">0j</h1>	<b>Style Name</b> <h1 style="text-align: center;">QUARTZ LC</h1>
--	--	---

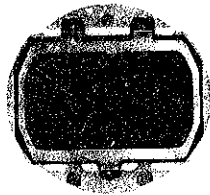

**Characteristics**

Casing diameter : 27.05  $\phi$  mm  
 Maximum height : 8.50 mm  
 Frequency of quartz crystal oscillator: 32,768Hz  
 (Hz Hertz, . . . . . Cycle per second)  
 Time display: Consecutive and accumulative digits indication  
 in hours, minutes and seconds using Single Crystal  
 Display (Nematic Liquid Crystal, FE-type)  
 Time adjusting method :  
 Hour, minute and second digits can be selected and adjusted  
 instantly by depressing the front touch-buttons.  
 Second digits fly back to 0 digit by the first depressing.  
 Time micro-adjustor: Trimmer condenser system  
 Side button: Designed with locking device for time adjusting finish  
 Illumination light for digital display panel :  
 Illuminated in coordination with the touch-button depressing



383 649



782 649

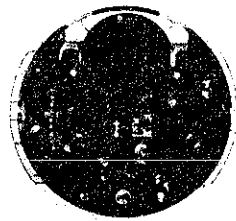

4001 645



4245 649



4398 649

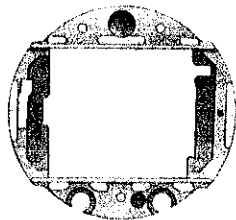

4408 649



4501 649

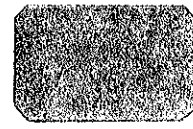

4521 643

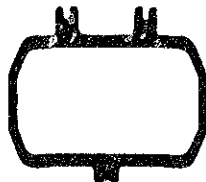

4540 649



U.C.C.386

Calibre No. <b>0624A</b>		Jewels <b>0j</b>	Style Name <b>QUARTZ LC</b>	
PART NO.	PART NAME	PART NO.	PART NAME	
383 649	Setting lever			
782 649	Setting lever spring			
4001 645	Circuit block			
4245 649	Setting switch spring			
4398 649	Battery guard			
4408 649	Frame for liquid crystal panel			
4501 649	Liquid crystal panel			
4521 643	Reflecting mirror			
4540 649	Spring for liquid crystal panel			
U.C.C.386	Silver oxide battery			

# TECHNICAL GUIDE

## SEIKO

## DIGITAL QUARTZ

CAL.0624A

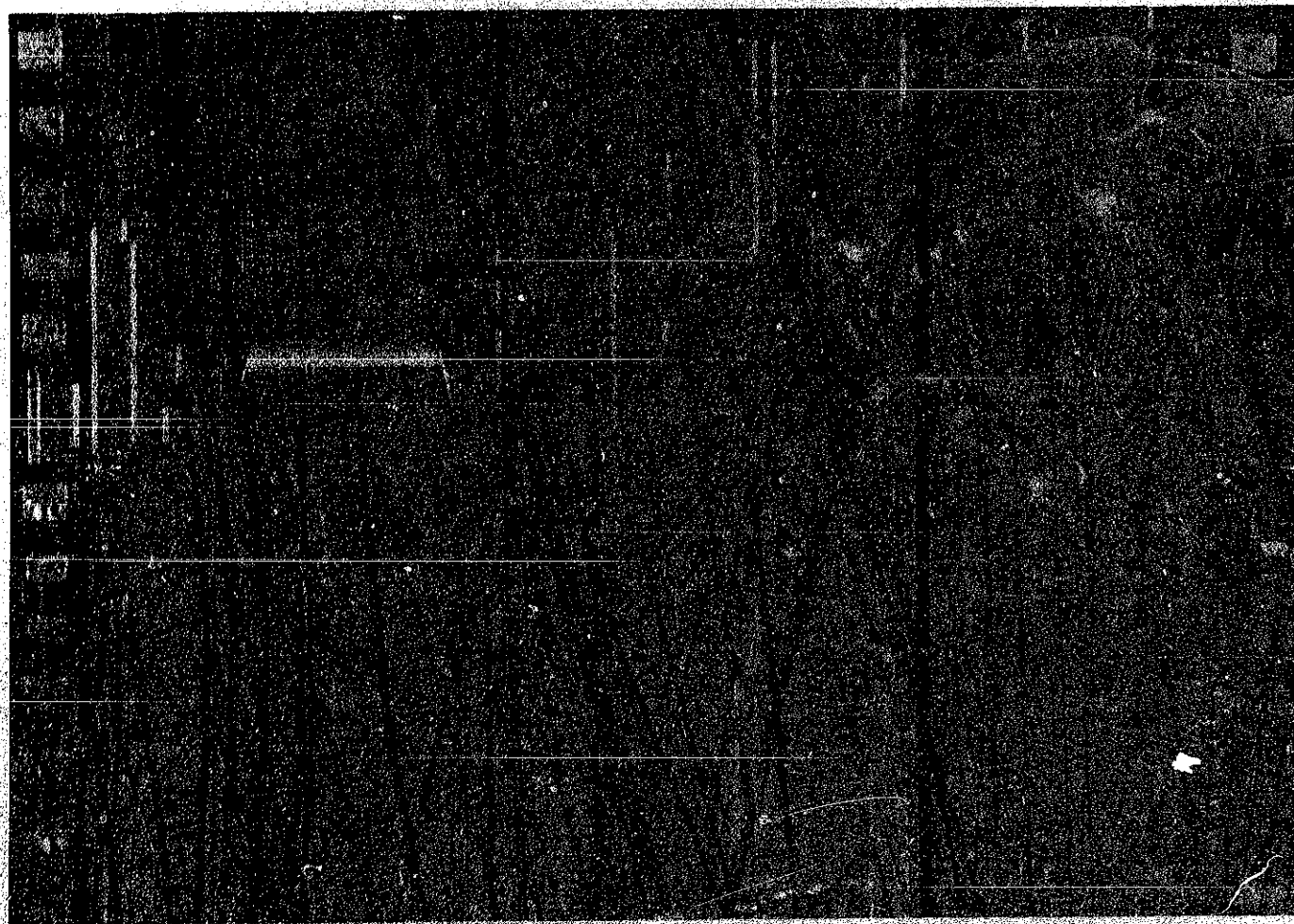

### CONTENTS

<b>I. Specifications and Features</b> .....	1
1. Specifications .....	1
2. Features .....	1
<b>II. Functioning</b> .....	2
1. Outline of functioning .....	2
2. Liquid crystal .....	2
3. How to set the time .....	4
<b>III. Disassembling and Reassembling</b> .....	5
1. After-servicing instruments and materials .....	5
2. How to use the after-servicing instruments and materials for repair .....	6
3. Disassembling and reassembling of case .....	9
4. Disassembling, reassembling and lubricating of the movement .....	13
5. Cleaning .....	17
<b>IV. Checking and Adjustment</b> .....	19
1. Guide for checking and adjustment .....	19
2. Explanation of malfunction .....	20
3. Segment and MOS IC output terminal .....	21
4. Checking and adjustment .....	22
A. Check battery voltage .....	22
B. Check contact of MOS IC and liquid crystal panel .....	22
C. Check liquid crystal panel and circuit block .....	23
D. Check current consumption .....	23
E. Check accuracy .....	23
F. Time accuracy adjusting .....	24
G. Check hour and minute setting, second digit condition .....	24
H. Check setting mechanism .....	24
<b>V. Packing and maintenance of the spare parts</b> .....	25

Calibre 0624

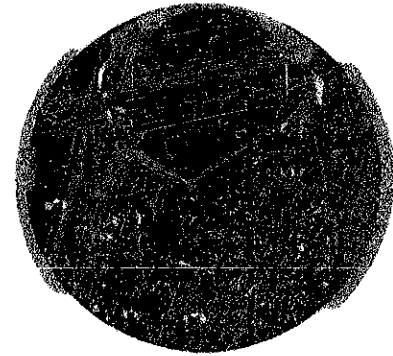
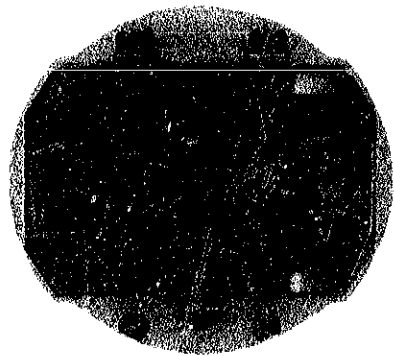

Movement

## I. SPECIFICATIONS AND FEATURES

### 1. Specifications

Item	Caliber	0624A
Display system		12-hour Digital Display System showing hour, minute and second
Display medium		Single Crystal Display (Nematic Liquid Crystal, FE (field effect)-type)
Operation		Selection and setting system using push time adjusting buttons on the front panel * Instant hour and minute adjusting device (can be adjusted separately) * Second digits return to "0" digit with each depression * Lock switch * Illuminating light
Crystal oscillator		32,768 Hz (Hz = Hertz . . . cycles per second)
Loss/gain		Loss/gain at normal temperature Mean monthly rate: less than 10 seconds (Annual rate: less than 2 minutes) Temperature compensation device
Casing diameter		27.0 mm $\phi$
Height		8.5 mm
Operational temperature range		-10°C ~ +60°C (14°F ~ 140°F)
Regulations system		Trimmer condenser
Battery power		Silver oxide battery (U.C.C. 386) Battery life is over one year
IC (Integrated circuit)		C-MOS-LSI . . . 1 pce. Hybrid-IC . . . . 1 pce.

### 2. Features

- (1) The crystal oscillator generates a highly stabilized oscillation.
- (2) Extensive minimization of the movement and simplified blocks of each component facilitate after-servicing.
- (3) Single Liquid Crystal developed by SEIKO is used for display medium, which enables a very clear digit to be displayed on the panel.
- (4) Digital display system indicates the time clearly. (even in second)
- (5) Illuminating light enables the time to be read in the dark.
- (6) Time adjusting is done simply by the Selection and Setting system developed by SEIKO.
- (7) Lock switch prevents the time adjusting button from being pushed by mistake.

## II. FUNCTIONING

### 1. Outline of functioning

- (1) When voltage is supplied to the crystal oscillator, it oscillates accurately at 32,768 Hz.
- (2) The oscillator circuit receives the 32,768 Hz oscillations and converts them into electric signals.
- (3) The frequency divider circuit converts them into the proper impulses, i.e., 1/2, 1/2, 1/2 for display.
- (4) The electric signal transmitted from the frequency divider circuit is properly arranged by the dividing and driving circuits to fit the display mechanism.
- (5) The electric signals transmitted from the dividing and driving circuits are transmitted to segments for the hour, minute and second on the liquid display panel.

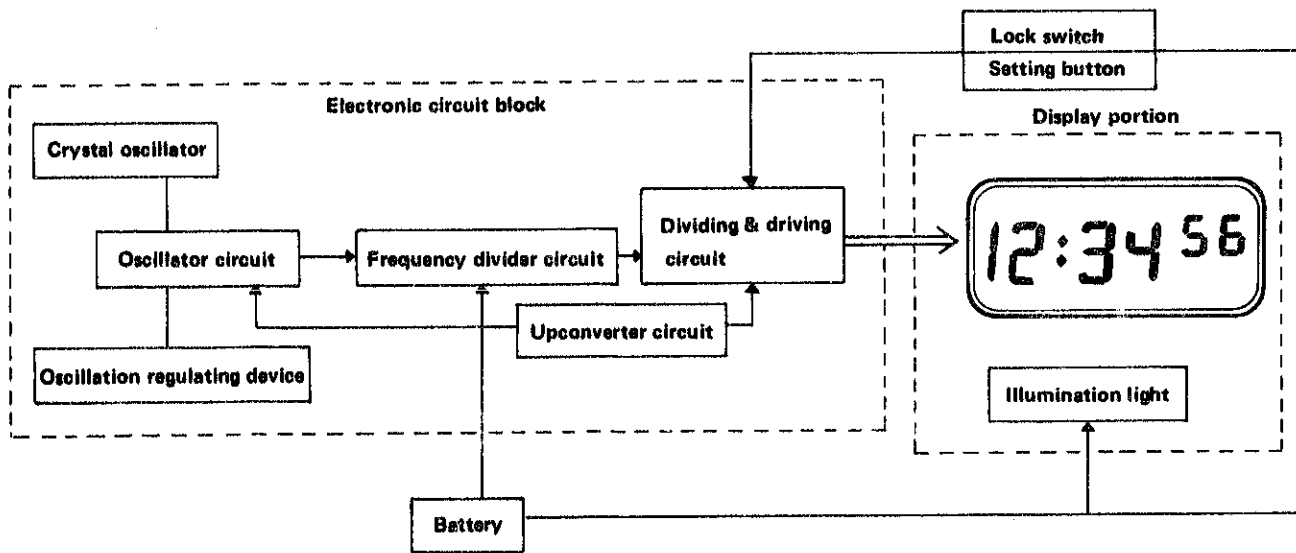

### 2. Liquid crystal

#### (1) Character of Liquid Crystal

The liquid crystal is a special organic compound, which has the intermediate characters of being both a liquid and solid body. Although configuration of the molecules of the liquid crystal is relatively in order but not stable, the molecule has fluidity. Therefore, the configuration of the molecules of liquid crystal is easily changed by impulsion of electricity, temperature and pressure, which makes it look like a colored or transparent body.

Character of Substance

Condition	Character
Solid body (crystal)	<ul style="list-style-type: none"> <li>• Solid</li> <li>• Configuration of molecule is regular.</li> </ul>
Liquid crystal	<ul style="list-style-type: none"> <li>• Liquidity</li> <li>• Configuration of molecule is regular.</li> </ul>
Liquid	<ul style="list-style-type: none"> <li>• Liquidity</li> <li>• Configuration of molecule is irregular.</li> </ul>

#### (2) Principles of FE type

The FE type, a kind of field effect pattern, is generally believed most advantageous among indicators for wrist watches because of its low voltage driving and low power consumption factors.

The FE type is of the following structure: That is, first wash clean and then rub two sheets of glass with a cotton cloth. Next, set together the glass sheets so that the rubbing courses may be at right angles to each other. When liquid crystal is placed between them, the molecules are arranged in a more or less twisted state since such molecules have the property of being lined up in the direction of liquid crystal molecules having been rubbed with the cotton cloth. Thus, on the upper and lower sides of the glass, the molecules are arranged in a twisted state of 90 degrees. The two polarizing sheets, with polarizing axes crossing rectangularly, are certain to completely interrupt waves of light but, if liquid crystal with molecules thereof being arranged in the 90° twisted state is put in between said 2 polarizing sheets, the light vibration surface rotates by 90 degrees, enabling the passage of light waves. This type is designed to control this process electrically and to visually check up on changes as desired. If, then, transparent electrodes are placed on both sides of the liquid crystal and then voltage is added, the liquid crystal molecules of the region cease to remain in the 90° twisted state and instead, come to be vertically arranged along the electric field. Then, as the result of light interruption, the region looks dark. Accordingly, if transparent electrodes are arranged in seven blocks (segments) as shown in the figure, it becomes possible to indicate numerals by combining those blocks properly.

Incidentally, as for the liquid crystal panel, if the temperature is below 0°C, its response grows slower. It should not be judged defective then, because, if the temperature comes back to the normal, the indication will be as initially intended.

Cross-Sectional View of FE type Structure

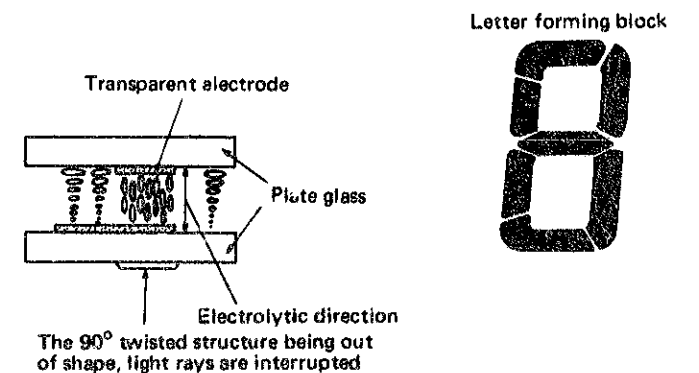
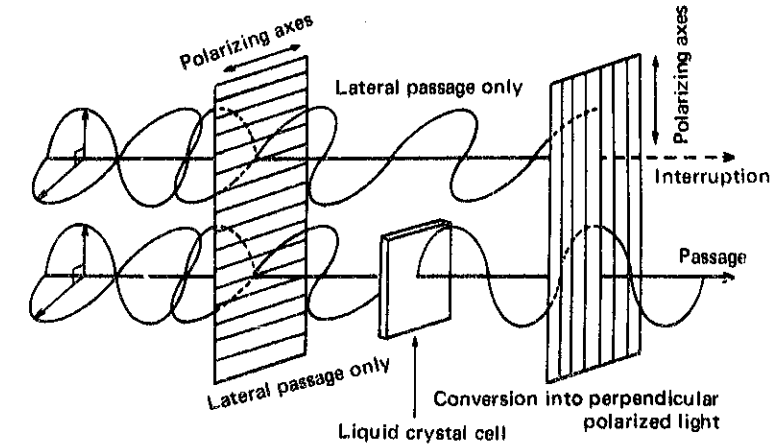
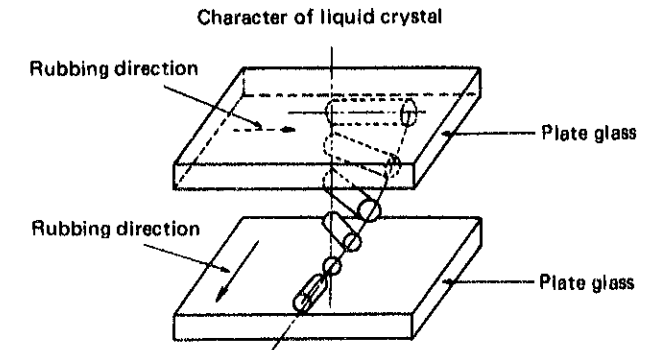
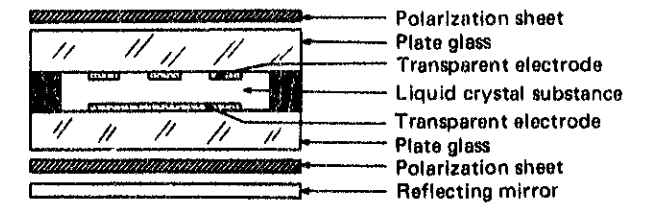

### 3. How to set the time

#### (1) How to set the time initially

1. Pull the lock switch out until a click is heard and the second digits start blinking. This indicates that the second digits are ready to be changed.
2. Push the setting button when the time signal is announced "0" second, the watch is reset to "00" second and starts immediately.
3. When setting the minute, push the selection button once and the minute digits start blinking. That indicates that the minute is ready to be changed. One minute is advanced by each depression of the setting button.
4. When setting the hour, push the selection button again and the hour digits start blinking. One hour is advanced by each depression of the setting button.
5. Push the lock switch back to the normal position after time setting.

#### (2) To set the second digits in accordance with the time signal

1. Pull out the lock switch.
2. Push the setting button when the time signal is announced "0" second, the watch is reset "00" second and starts immediately.
  - When the second indicates any numbers from "00" to "29," the second is reset automatically but when the second indicates numbers from "30" to "59," one minute is added and the second digits returns to "00," and starts again immediately.
 Refer to (1)-3. for minute setting.
3. Push the lock switch back to the normal position.

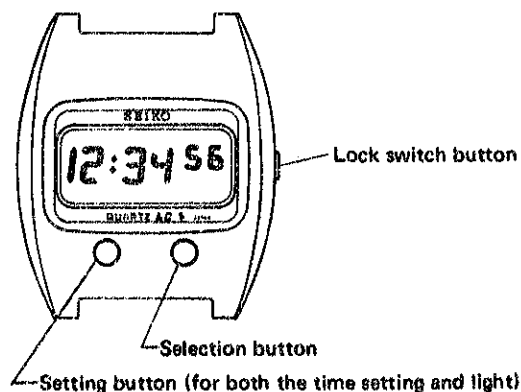

#### Example:

How to set the time from 12:58:54 to 1:05:00

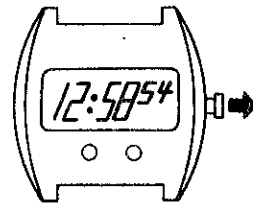

Pull out the lock switch, the second digits start blinking.

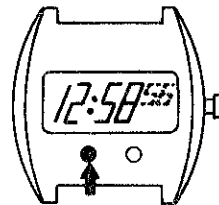

Push the setting button when the time signal is announced "0" second, the watch is reset "00" second and starts immediately.



Push the selection button and the minute digits start blinking. Now, one minute is advanced by each depression of the setting button.

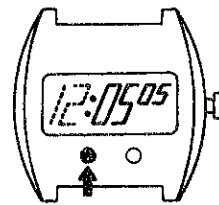

Push the selection button and the hour digits start blinking. Now, one hour is advanced by each depression of the setting button.

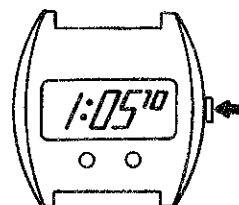

Now, all time setting procedures have been finished. Push the lock switch back to the normal position.

## III. DISASSEMBLING AND REASSEMBLING

### 1. After-servicing instruments and materials

For after-servicing of SEIKO Quartz Digital Cal. 0624A, the following after-servicing instruments and materials are necessary.

#### (1) Quartz Tester

Used to check time accuracy (daily rate) of both QT-10 and QT-100. The microphone is different, however.

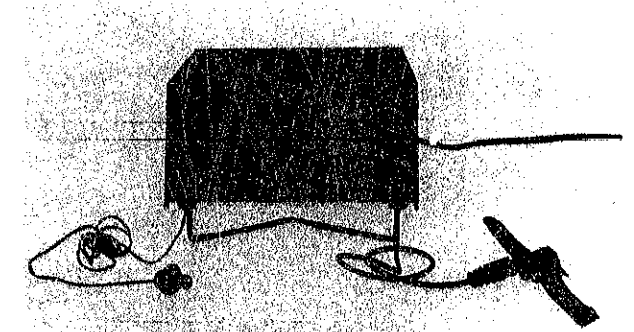

• Electric-field detection microphone for QT-10

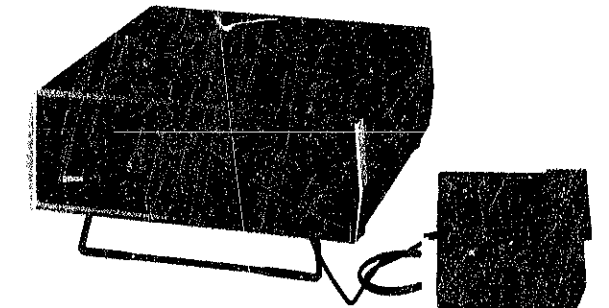

• Oscillation detection microphone for QT-100

#### (2) Tester

Used to check battery voltage and measure current consumption.

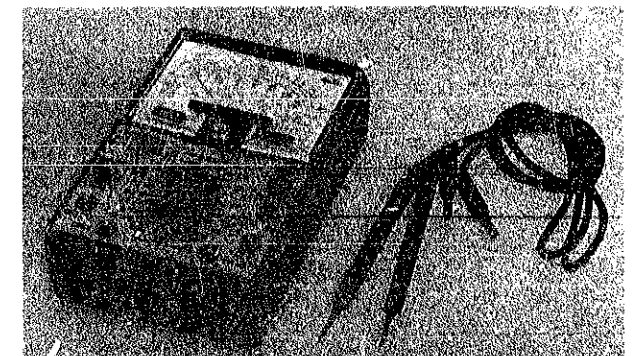

#### (3) Movement holder

Used for disassembling and reassembling of the movement.

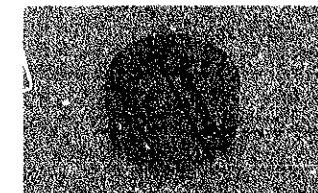

#### (4) Battery holding spring

Used for securing battery and flowing current when the movement is removed from the case.



## 2. How to use the after-servicing instruments and materials for repair

### (1) How to use Quartz Tester (QT-10)

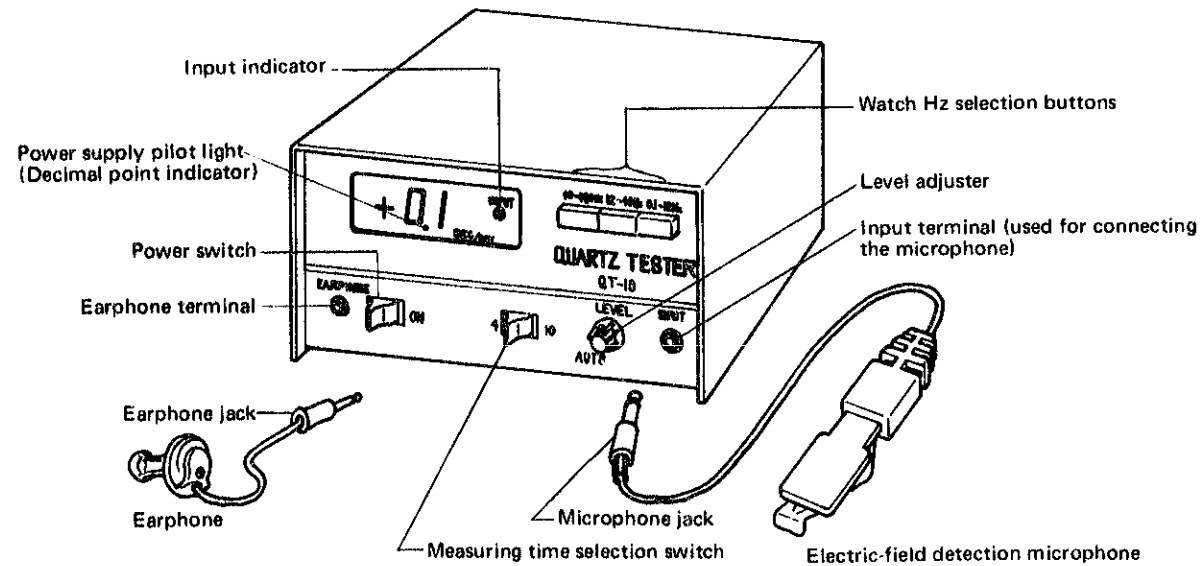

#### [Measuring time accuracy (daily rate)]

1. Insert the power supply cord plug into a power outlet.
2. Turn on the power switch. Make sure that the power supply pilot light is lit.
3. Attaching the microphone  
Insert the microphone jack into the input terminal.
4. Push the watch Hz selection button (White button, 12 ~ 40 Hz).

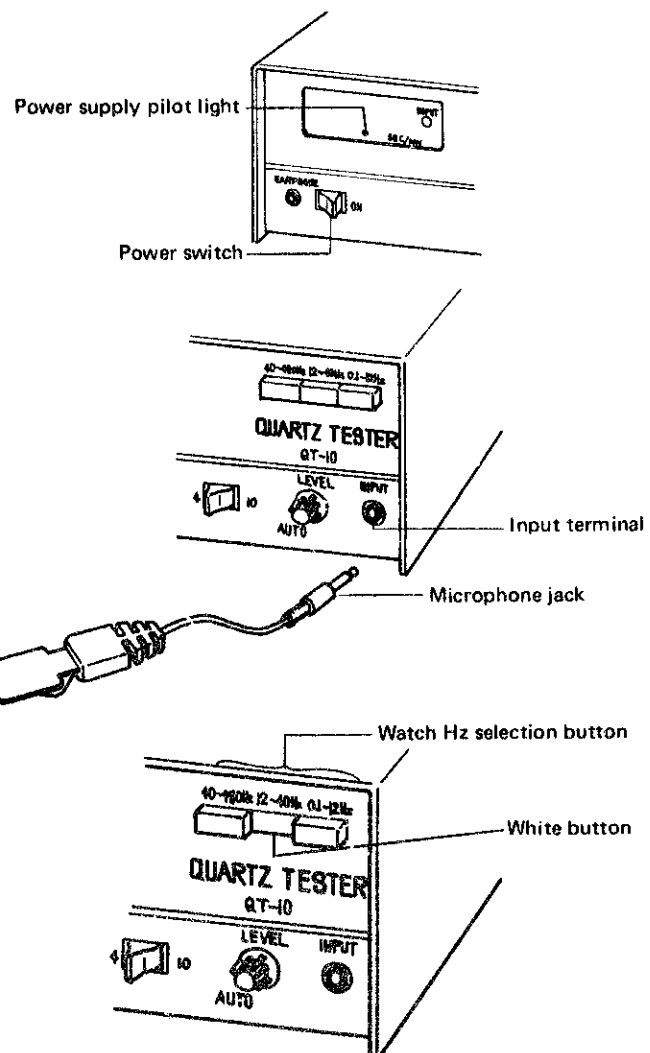

5. Turn the measuring time selection switch to the "4" or "10" position. As regards the Cal. 0624A, measurement is possible in either position.

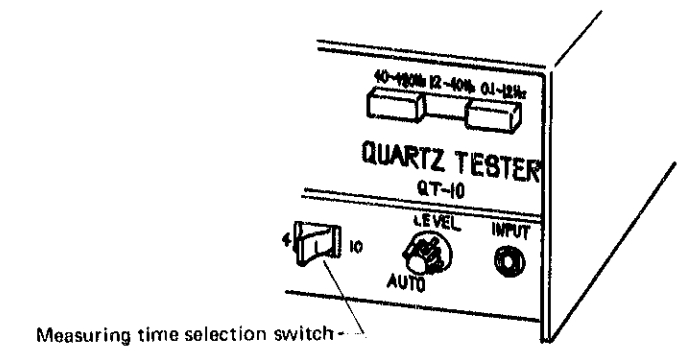

6. Insert the earphone jack into the earphone terminal of the Quartz Tester.

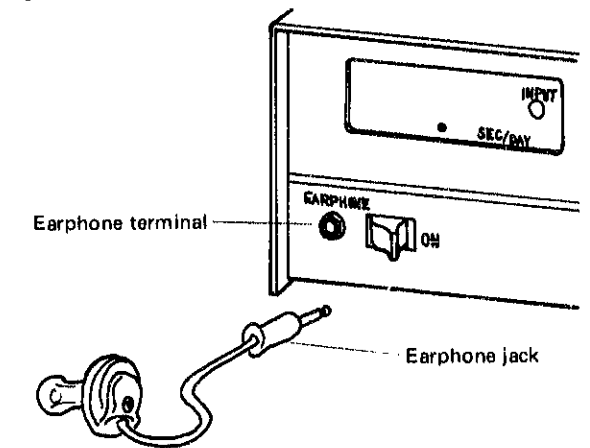

7. Clip the microphone to the watch

- In order that the microphone's flat surface may be in contact with the panel side of the watch, put the watch between the clip of the microphone from the opposite side of the lock switch button of the watch. That is, nearest the hour digit. This is because the microphone selects the electric field of the liquid crystal panel. It may be impossible to measure time when the digits on the panel display change. The hour digit portion does not change quickly. Put conductive rubber sheet between the microphone and the case back to prevent the watch from being scratched.

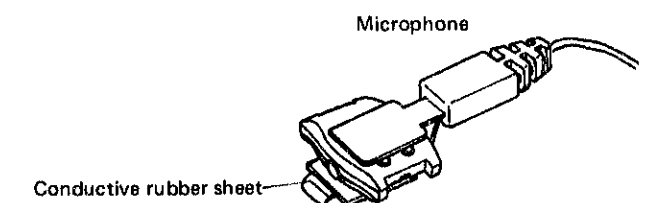

- Put on the earphone and move the microphone slightly. Hold the watch and microphone firmly between the fingers to insure a good contact. The input indication light will be continuously lit if this procedure is followed. While the level adjuster is in the AUTO position, measurement is feasible, but whenever the input indication light blinks or goes off, adjust it by turning the level adjuster so that the indication light is continuously lit.

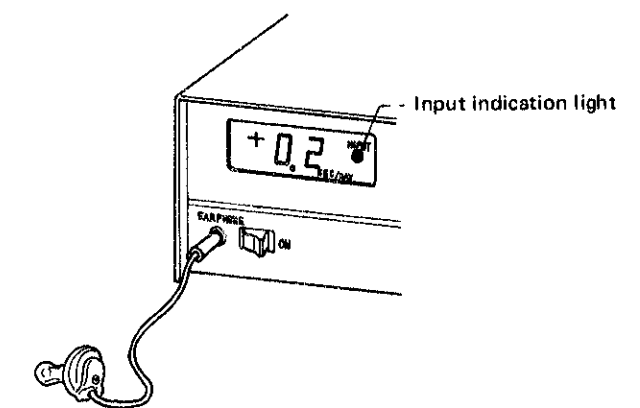

8. The daily rate is readable on the indication section.

- When the daily rate is excessive there will be no indication.

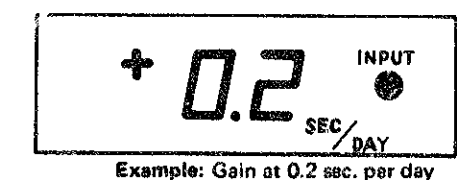



[Time accuracy adjusting method]

The time adjusting procedure is almost the same as that for time accuracy measuring, but, since the adjustment is done while the watch is in a state of movement, both procedures differ somewhat from each other as to the method of fitting the microphone to the watch.

1. Connect the power cord.
2. Turn on the power switch.
3. Attach the microphone.
4. Push the watch Hz selection button "12 ~ 40 Hz" (white button).
5. Turn the measuring time selection switch to the "4" or "10" position.
6. Connect the earphone jack.
7. Clip the microphone to the watch.
  - Fix the battery with the battery holding spring.
  - In order that the microphone's flat surface may be in contact with the panel side of the watch, put the watch between the clip of the microphone from time adjusting button side of the watch. Also, insert a vinyl sheet to protect the panel from scratches.
  - Place the microphone so that its curved surface is in contact with the battery.
  - Put on the earphone and confirm the sound audible. Then, the input indication light is continuously lit. Measurement must be made while the level adjuster is in the AUTO position.
8. While reading the daily rate on the indication section, time adjustment is made by turning the trimmer condenser.

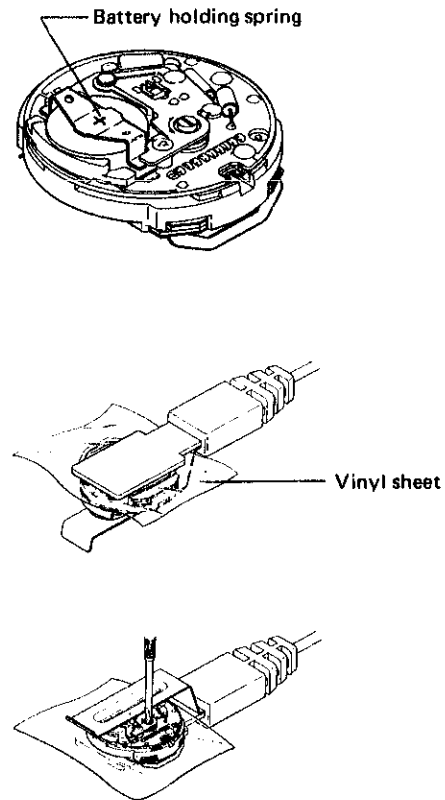

(2) How to use the Quartz Tester (QT-100)

- In the case of QT-100, use the oscillation detection microphone.
- Measurement is the same as for the analog type quartz watch.

Remarks:

Place the watch on the microphone as shown in a photo.

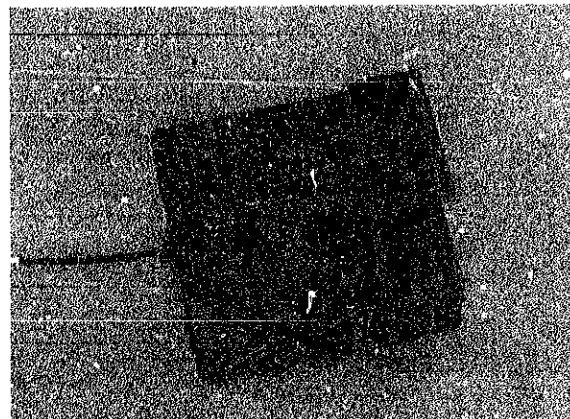

3. Disassembling and reassembling of case

(1) Procedures

Disassembling procedures Figs. ① ~ ⑪

Reassembling procedures Figs. ⑪ ~ ①

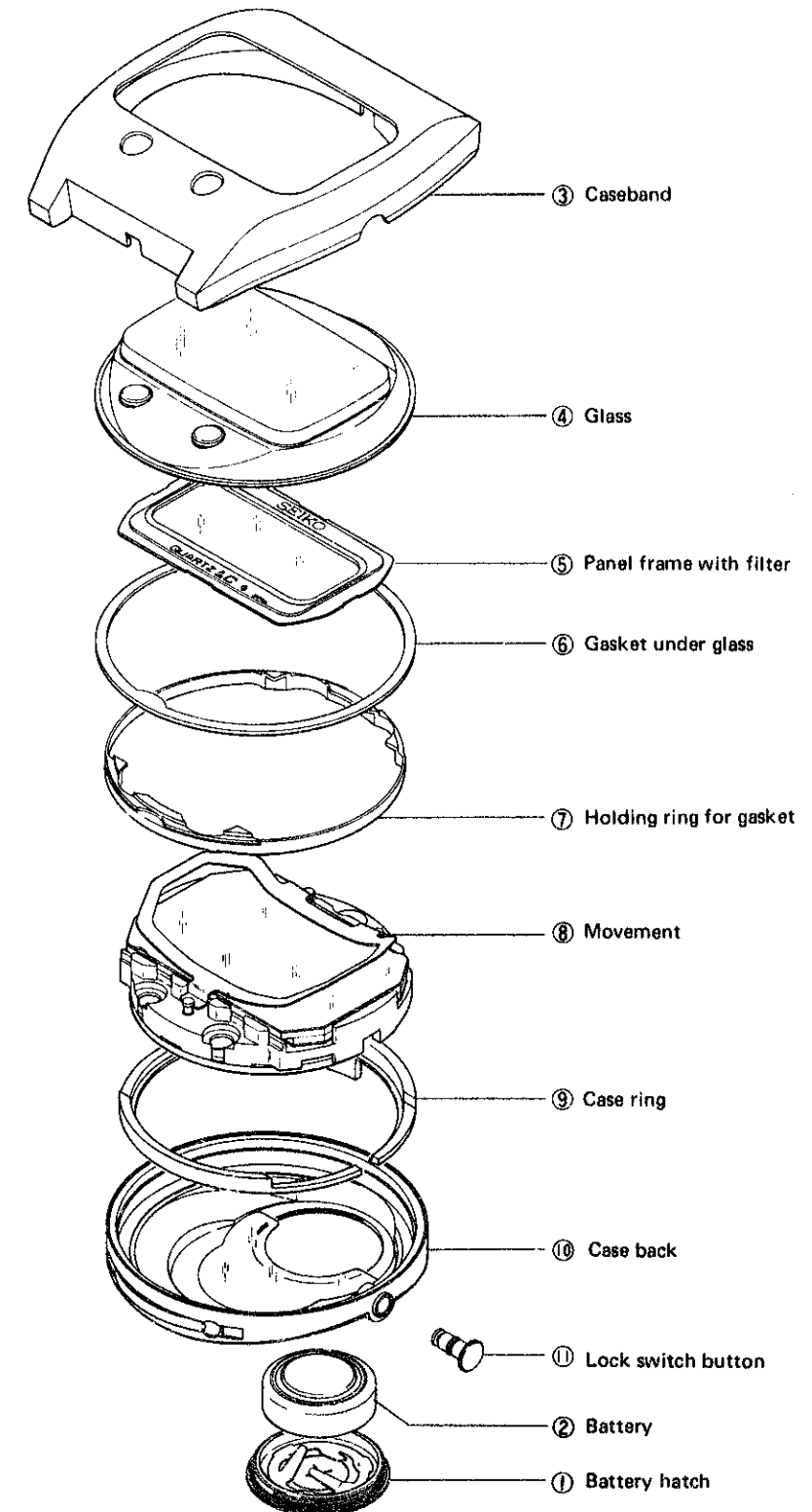

(2) Remarks for disassembling and reassembling of the case

• Remarks for disassembling

Caseband

- To remove the caseband, first remove the leaf spring A (near the guide pin) holding the caseband and case back firmly with the fingers, and then remove the leaf spring B.

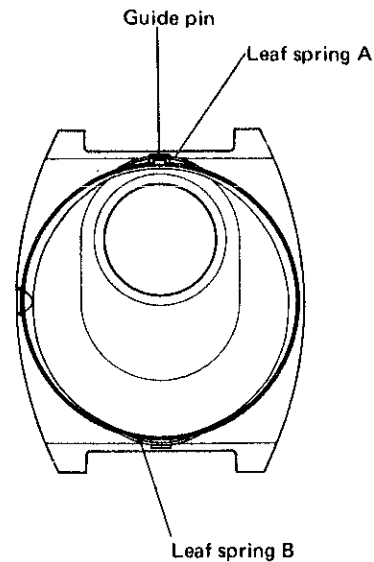
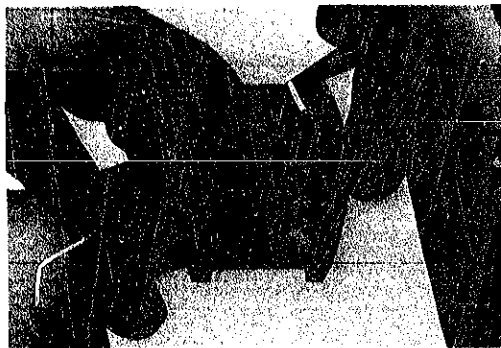

Panel frame with filter

- Handle the plate with filter as shown in a diagram so as not to scratch the filter.

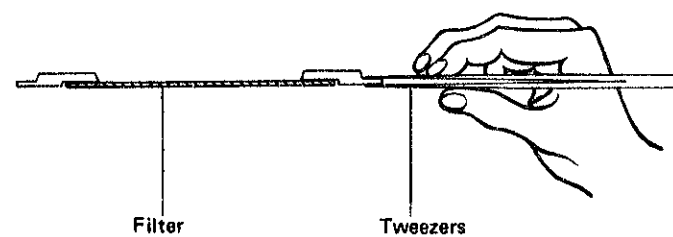

• Remarks for reassembling

Movement

- After the movement has been set in, check to see if the lock switch button can be pulled out and pushed back.

Gasket

- Be careful not to twist the gasket when setting in the holding ring.

Panel frame with filter

- Before assembling the panel frame with filter, remove dust and lint from the liquid crystal panel and the panel frame with filter with brush.

Glass

- Prior to assembling the glass, make sure that the hook-ups for time adjusting buttons are set in position.

**Note:** Check if the hook-ups turn smoothly.

- Remove dust and lint from the inside face of the glass.
- With the glass pressed against the gasket, check the cushioning condition all round the gasket. The gasket should be free of roll, twist and dust.
- Be careful not to make any dislocation between the glass and the panel frame.

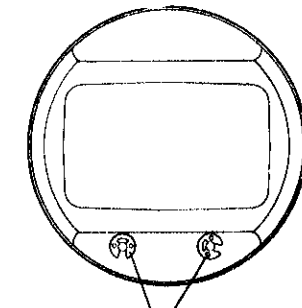

Hook-ups for time adjusting buttons

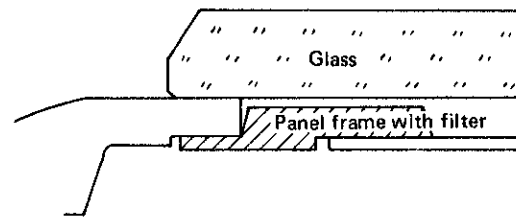

(Correct)

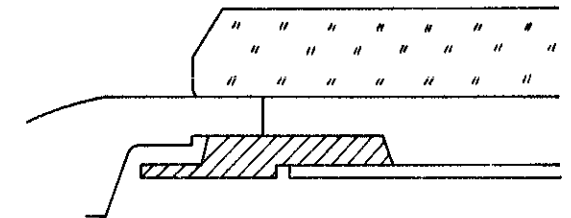

(Incorrect)

Caseband

- With the glass pressed to the case back, attach the caseband. (See next page)
- Check if the two (2) leaf springs are properly fixed.
- Check if the lock switch button and time adjusting buttons work normally after assembling the caseband.

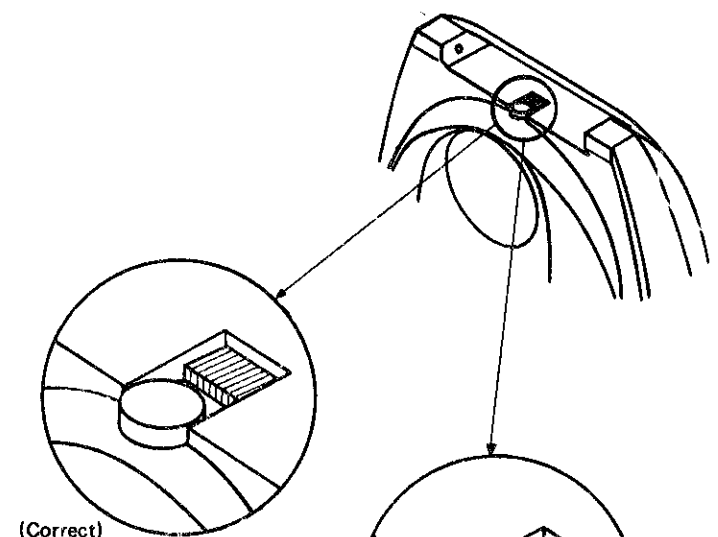

(Correct)

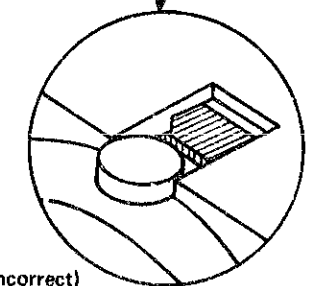

(Incorrect)

● How to reassemble the caseband

1. Hold the case back and the glass firmly with fingers.

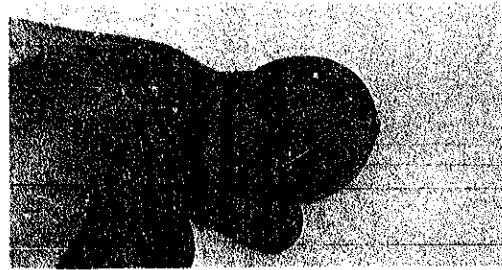

2. How put the caseband on.

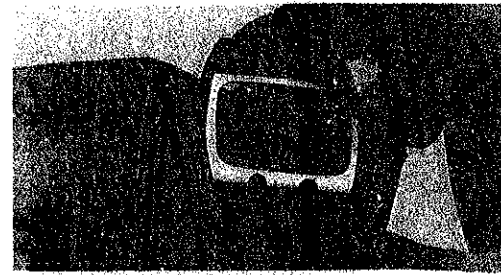

3. Transfer the watch to the other hand. At this time, be careful not to make dislocation between the glass and the case back.

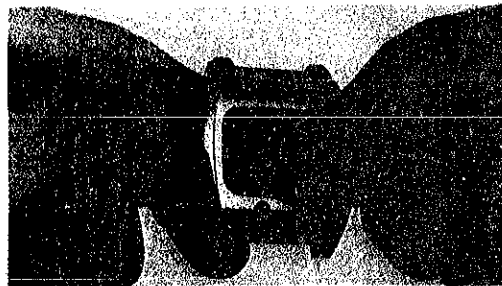

4. Assemble the caseband in the correct position.



5. Give a push to the leaf spring (appearing on the opposite side of the guide pin) with tweezers.

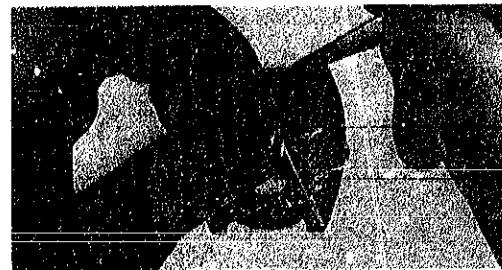

6. Give a push to the leaf spring on the guide pin side.



7. Hold the caseband and case back together tightly, and make sure that the two (2) leaf springs are reassembled properly.

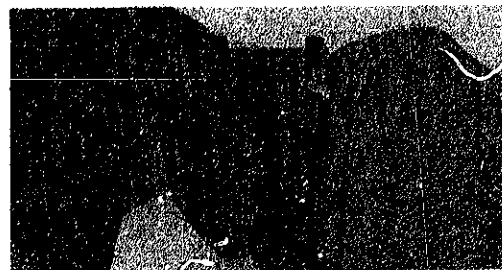

4. Disassembling, reassembling and lubricating of the movement

(1) Procedures

Disassembling procedures Figs. ① ~ ⑨  
 Reassembling procedures Figs. ⑨ ~ ①  
 Lubricating ∞ SEIKO Watch oil S-6  
 Normal quantity

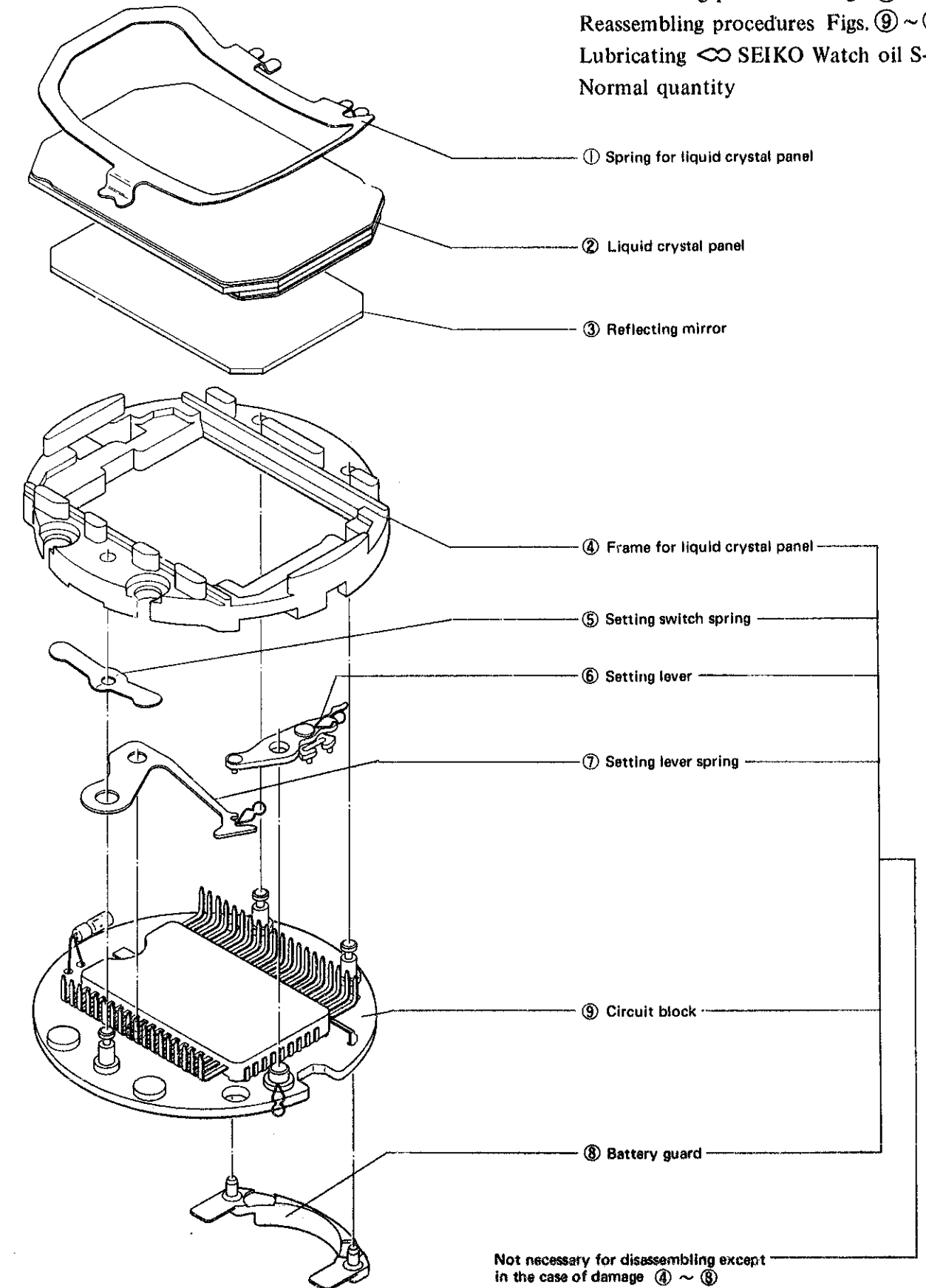

Not necessary for disassembling except in the case of damage ④ ~ ⑧

(2) Remarks for disassembling and reassembling of movement

• *Disassembling*

Disassembling of the spring for liquid crystal panel

- Disassembling procedures

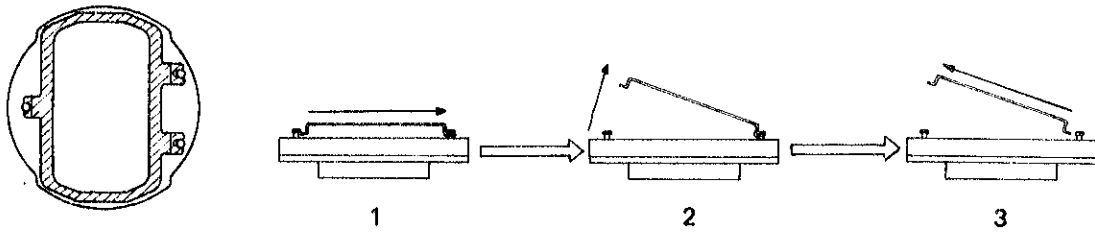

Liquid crystal panel

- Use fingercods to disassemble and reassemble the liquid crystal panel.

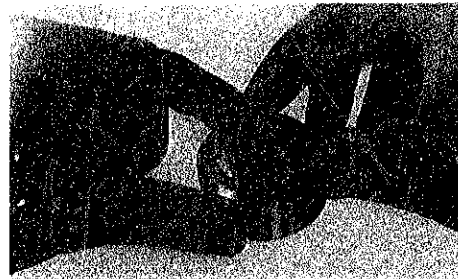

Frame for liquid crystal panel  
(Not necessary to remove it unless damaged.)

- In order to remove the frame for liquid crystal panel, insert a pair of tweezers into the side of the guide pins (3 pcs.) for the frame for the liquid crystal panel, and gradually raise the frame as shown in the photo.

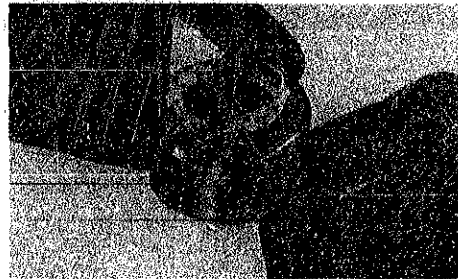

Setting lever (Not necessary to remove it unless damaged.)

- Don't pick up the thin spring with tweezers.

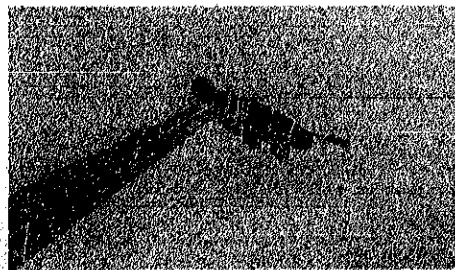

Correct

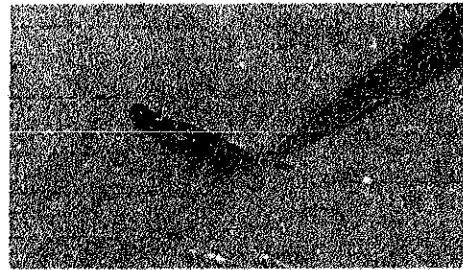

Incorrect

• *Reassembling*

Setting switch spring

- Make sure to assemble it in the correct direction.

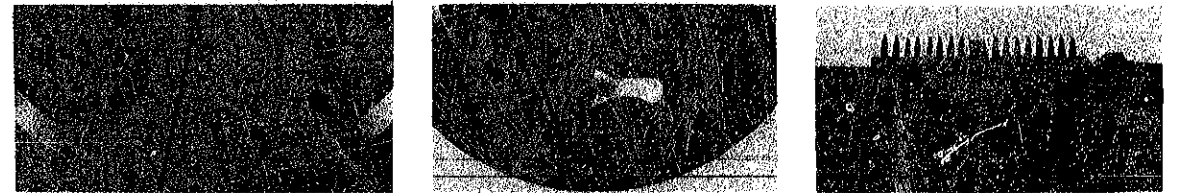

Frame for liquid crystal panel

- Hold it horizontally and push in gradually.

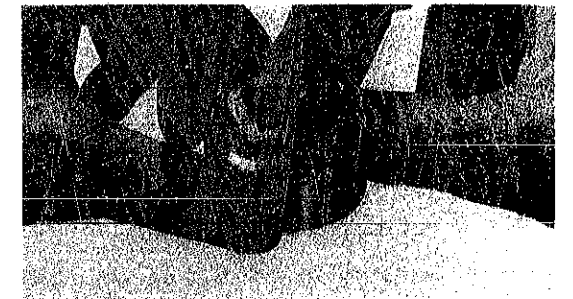

- Be careful not to bend the MOS IC terminal by pushing on the frame for the liquid crystal panel.

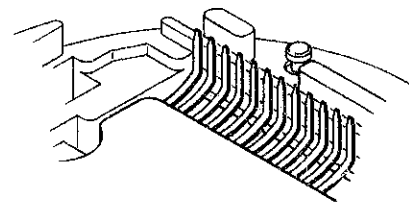

(Correct)

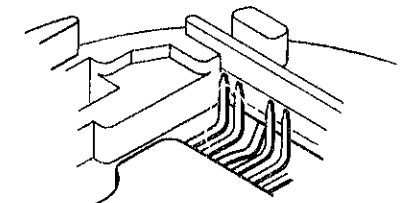

(Incorrect)

- Before reassembling the frame for the liquid crystal panel, check to if the two (2) terminals of the light are separated. They should not touch each other.

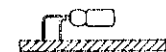

Correct

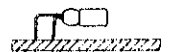

Incorrect

- When reassembling the frame for liquid crystal panel, be careful not to break the bulb.

Frame for liquid crystal panel

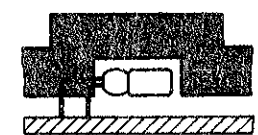

Correct

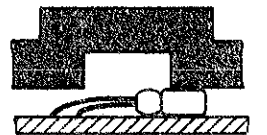

Incorrect

- After reassembling the frame for liquid crystal panel, check the bulb position. When the bulb position is low, raise it with tweezers. Keep the light up for effective illumination.

Circuit board

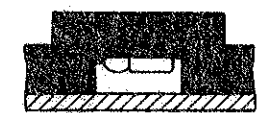

Correct

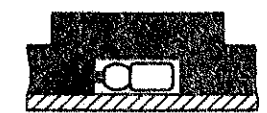

Incorrect

### Reflecting mirror

- Assemble the reflecting mirror with the mirror side down.
- Place it correctly on the frame for liquid crystal panel.

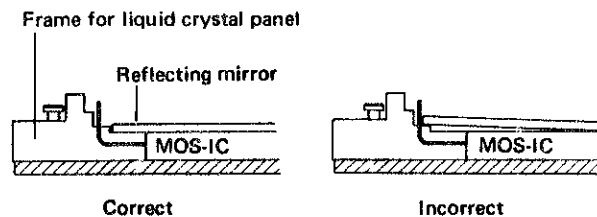

### Liquid crystal panel

- Before reassembling the liquid crystal panel, check the height of contacts of MOS IC terminals. If there are terminals found to be too low, raise them with tweezers.

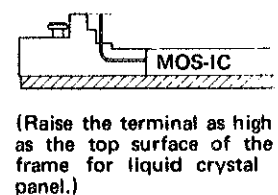
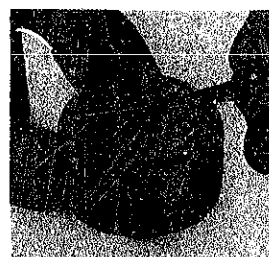

- Wipe off dust and lint with a brush from the MOS IC terminals and electrode of the liquid crystal panel.
- Reassemble the MOS IC terminals horizontally so as not to bend it.



### Spring for liquid crystal panel

- Reassembling

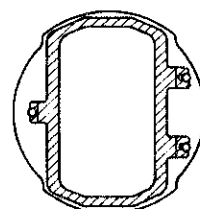
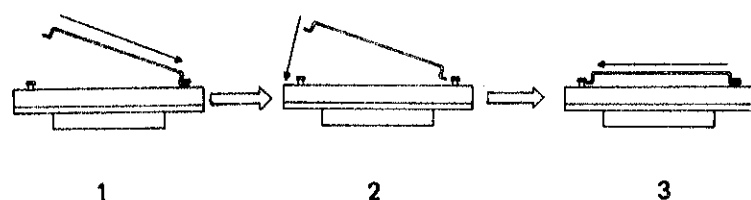

Be careful not to damage the edge of the liquid crystal panel with the spring for liquid crystal panel.

- When the spring for liquid crystal panel has been reassembled, insert the battery and make sure that all segments are lit.

If there is any segment which is left unlighted, refer to

**B** Check contact of MOS-IC and Liquid crystal panel

of "Checking and Adjustment" on page 22 for repair.

## 5. Cleaning

Since several parts of 0624A differ from conventional mechanical watches, use the following cleaning method when cleaning.

### How to Clean

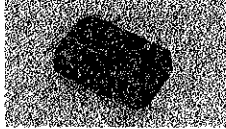
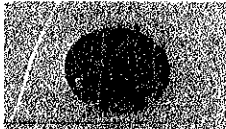
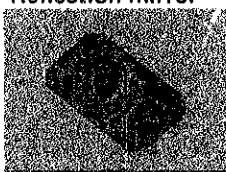
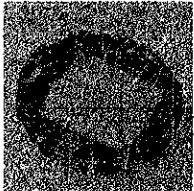
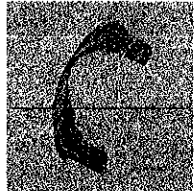
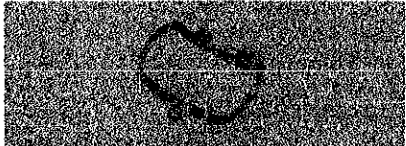
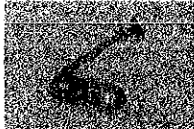
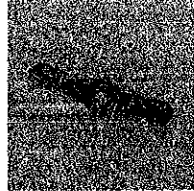
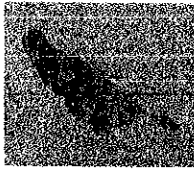
Parts name	Cleaning	Drying	Solution	Remarks
(1) Liquid crystal panel 	DO NOT CLEAN			Clean the electrode with a cloth moistened with benzine, the other parts should be cleaned with a brush.
(2) Circuit block 	DO NOT CLEAN			Wipe dust and lint off the MOS IC contacts with a brush. For other contacts, use a cloth moistened with benzine.
(3) Reflection mirror 	DO NOT CLEAN			Clean the reflecting mirror with a brush or cloth moistened with alcohol if contaminated. Be careful not to scratch the aluminum-evaporated surface.
(4) Plastic parts Frame for liquid crystal panel Battery guard  	Rinse or scrub with brush	Cool or air drying	Alcohol	
(5) Parts other than above Spring for liquid crystal panel Setting lever spring Setting switch spring Setting lever    	Rinse or scrub with brush	Cool or hot air drying	Benzine Trichloroethylene	When cleaning the setting lever, be careful not to damage the thin spring.

#### IV. CHECKING AND ADJUSTMENT

##### 1. Guide for checking and adjustment

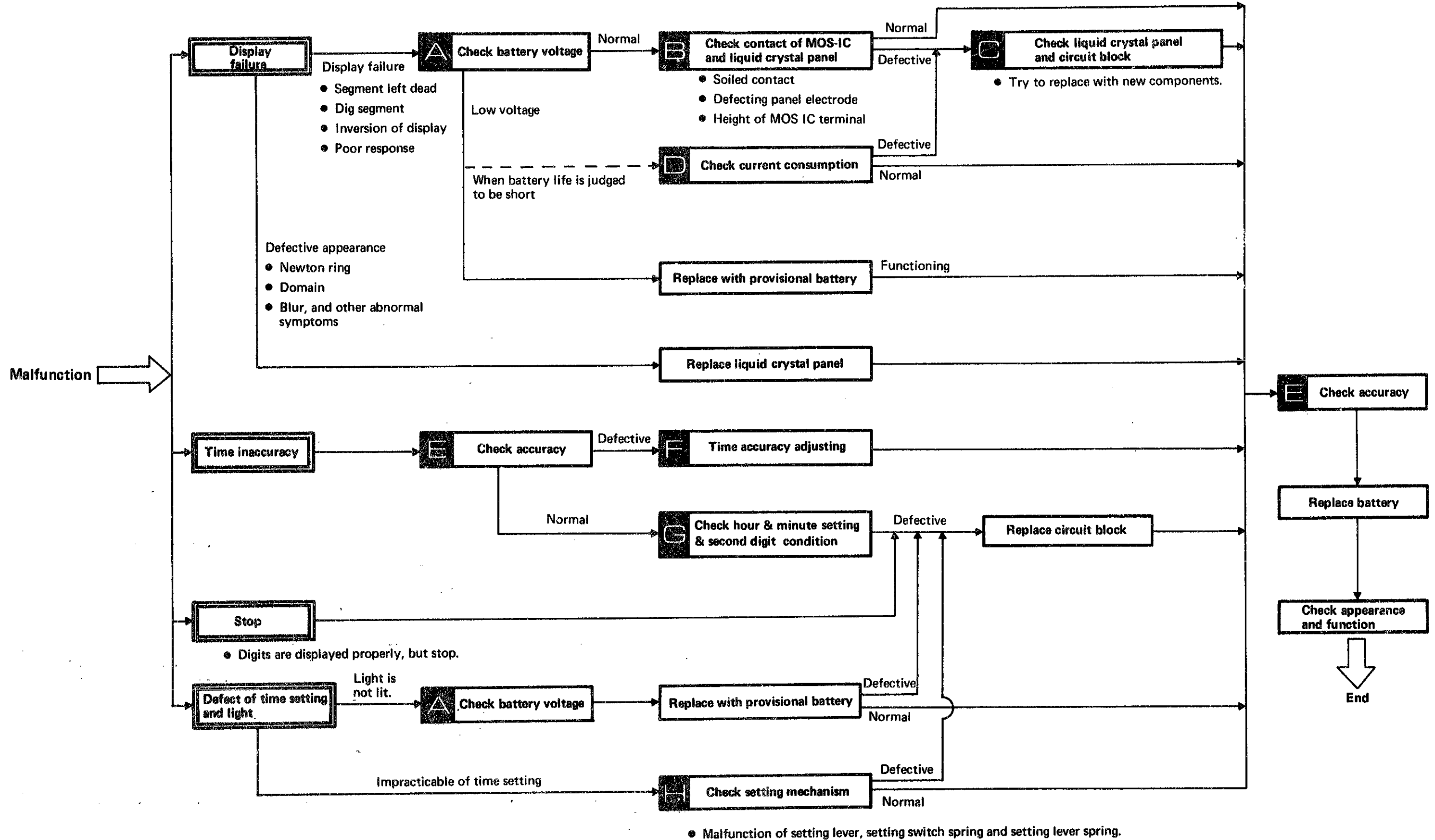

IV. CHECKING AND ADJUSTMENT

1. Guide for checking and adjustment

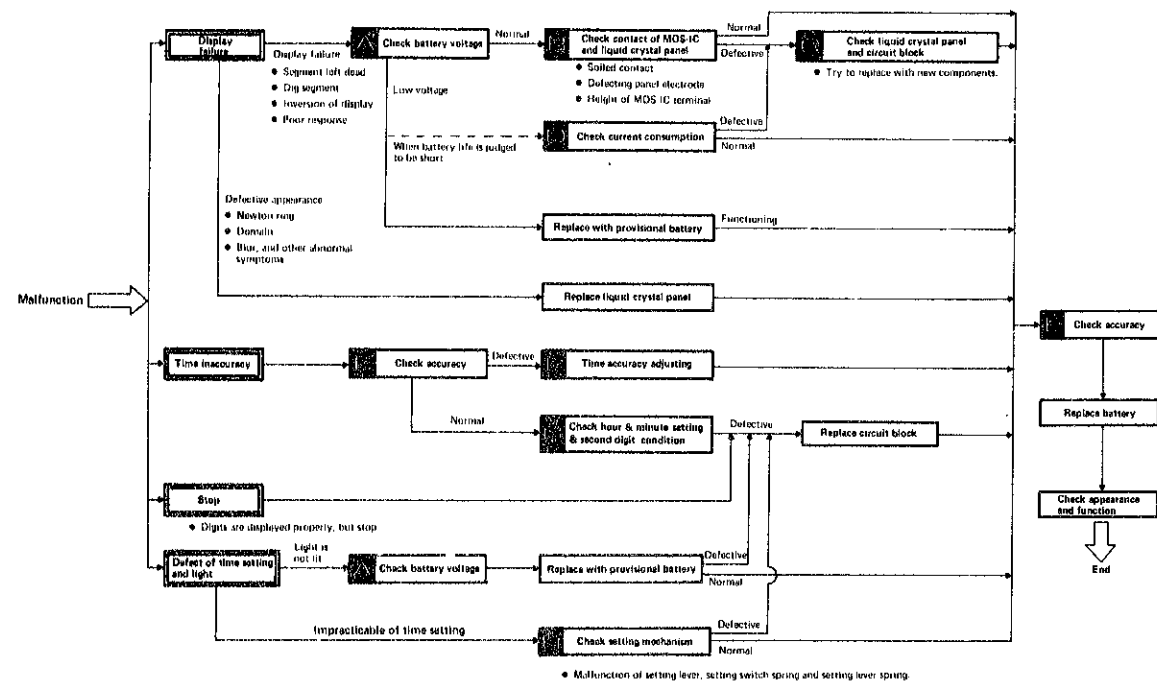

2. Explanation of malfunction

Symptom	Explanation
Inversion of display	<ul style="list-style-type: none"> <li>The segments which are to be lit are turned off, while the segments which should not be lit are turned on.</li> <li><b>Cause:</b> Common terminal is not connected to MOS IC terminal.</li> </ul> <p><i>Example:</i> </p>
Slow response	<ul style="list-style-type: none"> <li>On/Off operation segments (to be checked by minute or hour setting) is slow.</li> <li><b>Remarks:</b> The response of the liquid crystal panel becomes slow when it is below 0°C but its response becomes normal under normal temperatures.</li> </ul>
Newton ring	<ul style="list-style-type: none"> <li>The liquid crystal panel turns iridescent.</li> </ul> <p></p>
Run of polarizer adhesive	<p>Blurred as if water runs out. (Flow of adhesive from between polarized sheet and panel glass.)</p> <p></p>
Domain	<ul style="list-style-type: none"> <li>Some or all of segments show different contrast depending on the direction of view.</li> </ul> <p><i>Example:</i> </p>
Poor appearance of display	<p>Nick Hairline Uneven width <b>Others:</b> The reflecting mirror is stained.</p> <p></p>
Time inaccuracy	<p>Though Quartz Tester indicates the normal digit, a watch gains or loses excessively.</p> <ul style="list-style-type: none"> <li>The circuit block is usually suspected to be faulty. However, check the following before replacing the circuit block.</li> <li>1. Second digit condition . . . for more than one minute.</li> <li>2. Minute and hour setting condition: <ul style="list-style-type: none"> <li>Minute: For more than 60 minutes</li> <li>Hour: For more than 12 hours</li> </ul> </li> </ul>
Light will not light up or dim	<p><b>Remarks:</b> The digital display goes out while the light button is kept depressed.</p>



### 3. Segment and MOS IC output terminal

A complete knowledge of how the segment (Electrode of Liquid Crystal Panel) works with the MOS IC Output Terminal will provide the proper procedures for checking and adjusting.

#### (1) Segment

- Identification of the digit

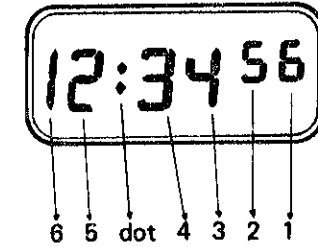

- Segment

One digit consists of seven (7) segments.



*Example:*

The segment in ○ is called "4d."

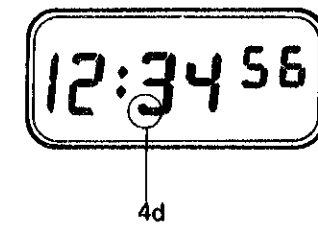

#### (2) Connection with MOS IC

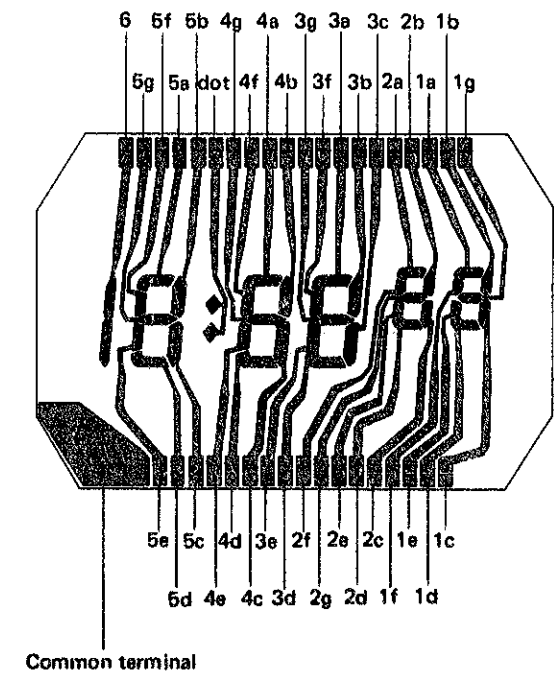
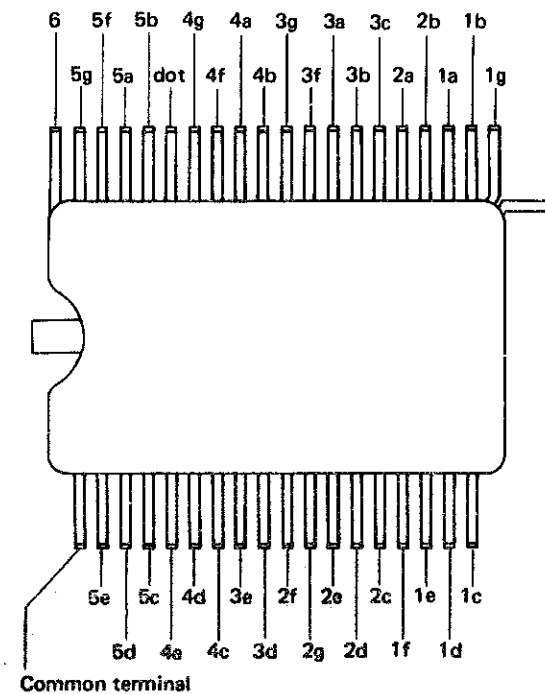



#### 4. Checking and adjustment

##### A Check battery voltage

Use the following procedures to check battery voltage.

###### (1) Set up the tester

Range to be used: DC 3V

###### (2) Measuring

- Probe Red (+) . . . . Battery surface (+)
- Probe Black (-) . . . . Battery surface (-)

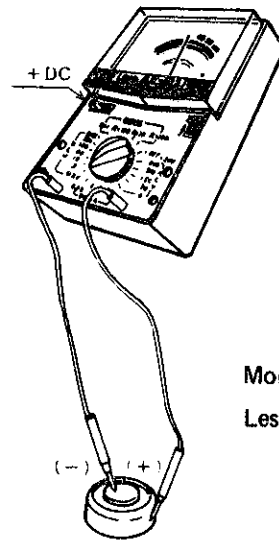

More than 1.5 V . . . Normal  
Less than 1.5 V . . . Defective

##### B Check contact of MOS IC and liquid crystal panel

After removing the liquid crystal panel, check the conductivity of the electrode of liquid crystal panel and MOS IC output terminals. (See page 21 for "Segment and MOS IC output terminal.")

###### (1) Check to see if there is any contamination on the liquid crystal panel electrodes and the MOS IC output terminal.

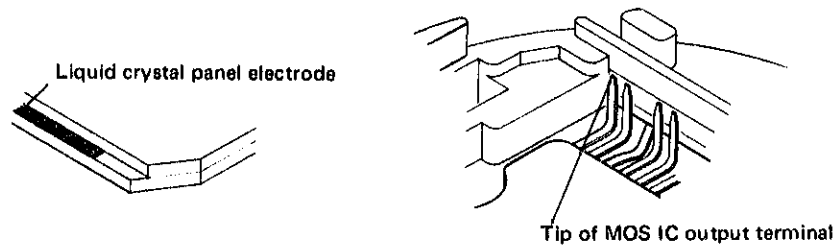

No foreign matter . . . Normal  
Foreign matter . . . . . Defective  
Wipe off any foreign matter

###### (2) Check for glass defects of the liquid crystal panel electrodes.

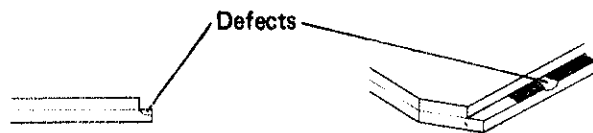

No glass defect . . . . . Normal  
Glass defects . . . . . Defective  
Replace the liquid crystal panel

###### (3) Check to see if the level of the MOS IC output terminal is too low.

- Raise, with tweezers, the MOS IC output terminals connected to the segments which fail to light up or are dim.

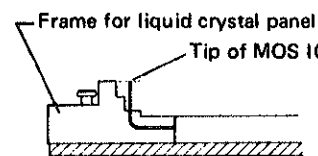

(Raise up the MOS IC output terminals as high as the top surface of the frame for liquid crystal panel.)

- After assembling the liquid crystal panel, check to see if the segments light up.

Light up . . . . . Normal  
Not light up . . . Defective  
. . . . . Proceed to



##### C Check liquid crystal panel and circuit block

After replacing the liquid crystal panel or the circuit block, check to see if the Watch works correctly.

##### D Check current consumption

Check to see if the current consumption is normal.

###### (1) Set up the Micro Test.

###### (2) Check

Push in and pull out the lock switch button, and check current consumption in each state.

Less than 10  $\mu$ A . . . . Normal  
More than 10  $\mu$ A . . . . Defective

Clip (red) . . . . . Case  
Probe (black) . . . . . Battery lead terminal



- Measurement with the tester

**Remarks:** Be sure to pull out the lock switch button before connecting the clip and probe of the Micro Test, but the lock switch button may be pushed in after it is connected. Don't push the time adjusting buttons during measurement.

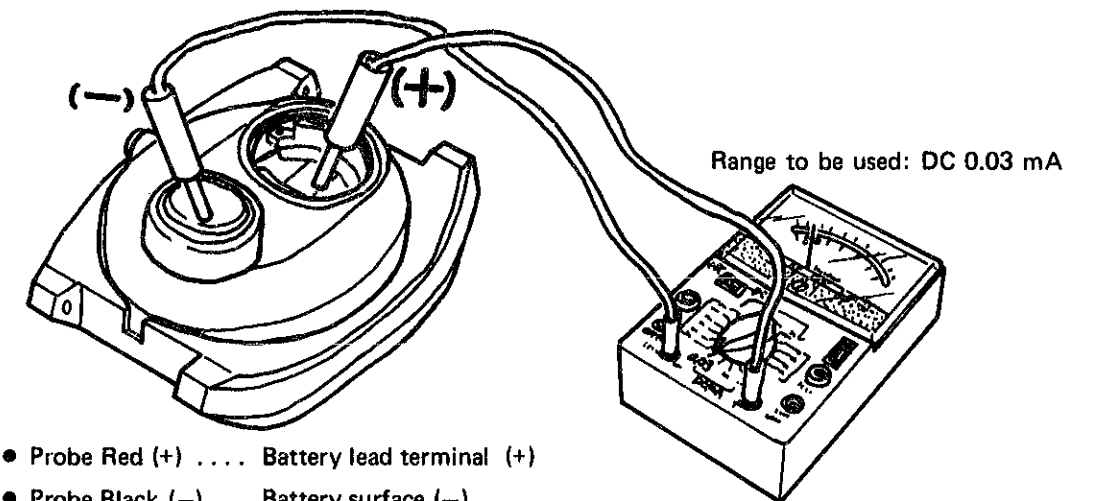

- Probe Red (+) . . . . Battery lead terminal (+)
- Probe Black (-) . . . . Battery surface (-)

##### E Check accuracy

- Use the electric-field detection microphone for QT-10. (See page 6 for "How to use Quartz Tester QT-10")
- Use oscillation detection microphone for QT-100.

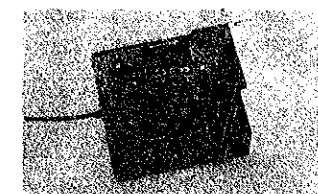

## V. PACKING AND MAINTENANCE OF THE SPARE PARTS

### F Time accuracy adjusting

Time accuracy of Cal. 0624 is adjusted by turning the trimmer condenser. (See page 8 for "Time accuracy adjusting method")

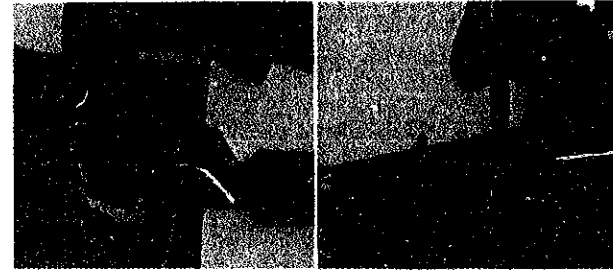

### G Check hour and minute setting, second digit condition

#### (1) Check the second digit condition.

- Check if the digit appears exactly at every second for more than one minute.

#### (2) Check if the hour and minute setting is made precisely. (See "How to Set the Time" on page 4)

- Minute setting condition . . . More than 60 minutes
- Hour setting condition . . . . More than 12 hours

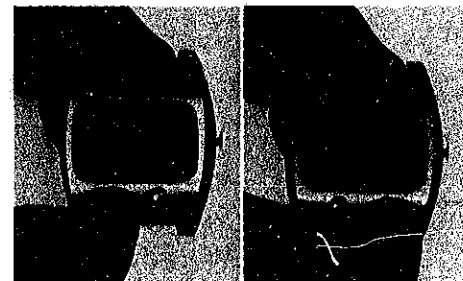

### H Check setting mechanism

Check to see if the lock switch button and the time adjusting buttons work correctly.

#### (1) Check to see if the lock switch button functions correctly

- Check to see that the thin spring of the setting lever touches the unlock terminal when the lock switch button is pulled out, and that the thin spring of the setting lever is set apart from the unlock terminal when the lock switch button is pushed in.

#### Remarks:

- Make sure that there is no foreign matter (dust, lint, etc.) on the thin spring of the setting lever and unlock terminal contacts.

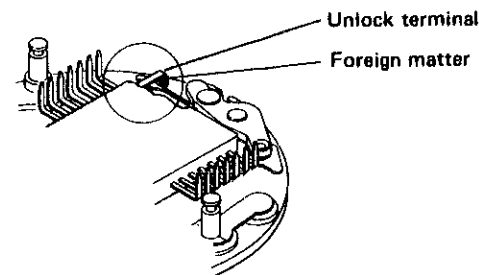

#### (2) Check to see if the setting button functions correctly.

- Check to see if the setting switch spring is touched to the pin of the circuit board as shown in the illustration. If it touches, correct it with tweezers.

#### Remarks:

- Make sure that there is no foreign matter (dust, lint) between the setting switch spring and the pin of the circuit board.

Wipe off dust and lint if there is any.

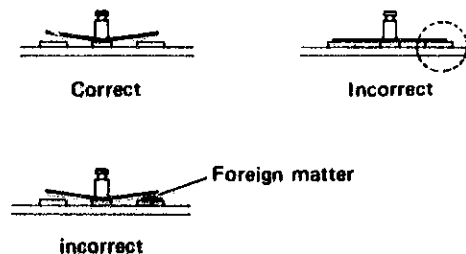

### • Packing and maintenance of the spare parts

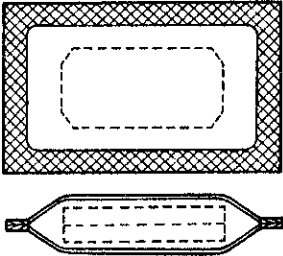
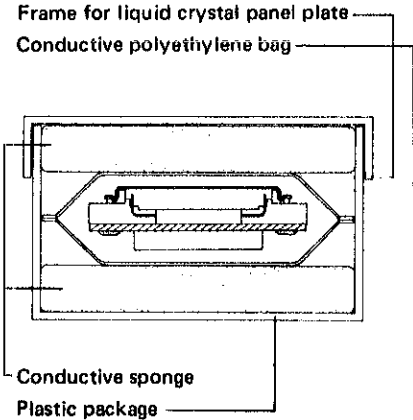
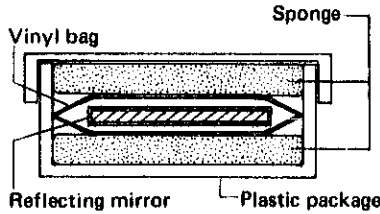
Parts name	Packing method	Remarks
Liquid crystal panel	<ul style="list-style-type: none"> <li>• Aluminum pack (airtight packing)</li> </ul>  <p>(The package protects the liquid crystal panel from sunlight and humidity.)</p>	<ul style="list-style-type: none"> <li>• Keep the liquid crystal panel in the following place to maintain the high quality.                             <ol style="list-style-type: none"> <li>1. Dark place</li> <li>2. Low humidity</li> <li>3. Low temperature</li> </ol> </li> </ul>
Circuit block <ul style="list-style-type: none"> <li>• Circuit block</li> <li>• Setting lever</li> <li>• Setting lever spring</li> <li>• Setting switch spring</li> <li>• Frame for liquid crystal panel</li> <li>• Frame for liquid crystal panel plate</li> </ul>	 <p>Frame for liquid crystal panel plate Conductive polyethylene bag Conductive sponge Plastic package</p>	<ul style="list-style-type: none"> <li>• MOS-IC is protected with the following three materials from static electricity.                             <ol style="list-style-type: none"> <li>1. Frame for liquid crystal panel plate</li> <li>2. Conductive polyethylene bag</li> <li>3. Conductive sponge</li> </ol> </li> <li>• The MOS-IC terminal is protected from being bent with the frame for liquid crystal panel.</li> <li>• The tip of the MOS-IC terminal is smeared with silicon grease for rust prevention</li> </ul>
Reflecting mirror	 <p>Vinyl bag Sponge Reflecting mirror Plastic package</p>	<ul style="list-style-type: none"> <li>• Be careful not to break the reflecting mirror (glass).</li> </ul>
<ul style="list-style-type: none"> <li>• Setting lever</li> <li>• Setting switch spring</li> </ul>	<ul style="list-style-type: none"> <li>• Blister package</li> </ul>	<ul style="list-style-type: none"> <li>• Be careful not to bend.</li> </ul>
Frame for liquid crystal panel Spring for liquid crystal panel Setting lever spring Battery guard	<ul style="list-style-type: none"> <li>• Vinyl bag</li> </ul>	